

Cluster Plate

Surgical Technique | *TriMed Ankle Fixation System*

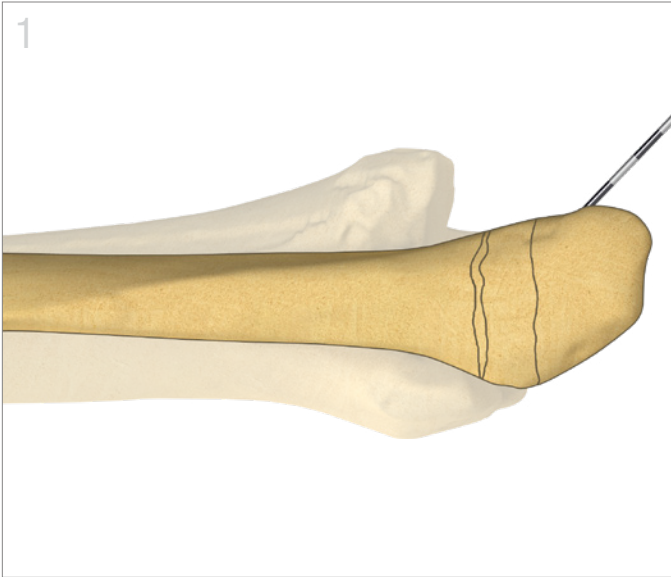

Exposure

- Approach the distal end of the fibula with a standard incision. Avoid excessive traction on soft tissue structures.
- Reduce and provisionally hold the reduction with forceps or K-wires as needed.

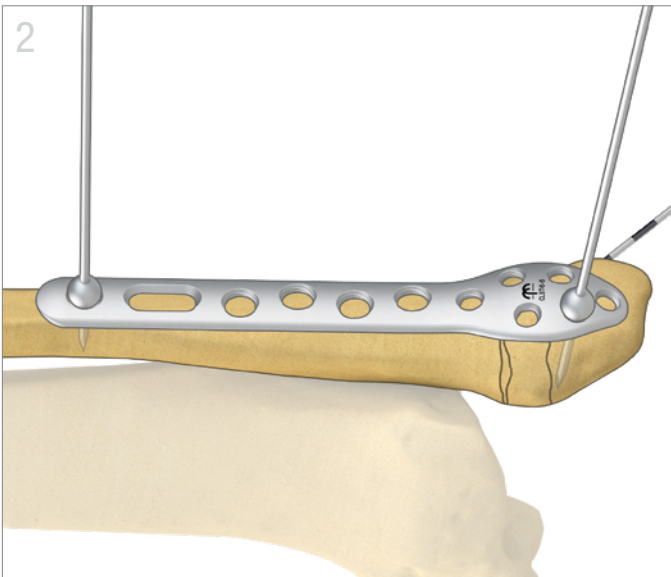
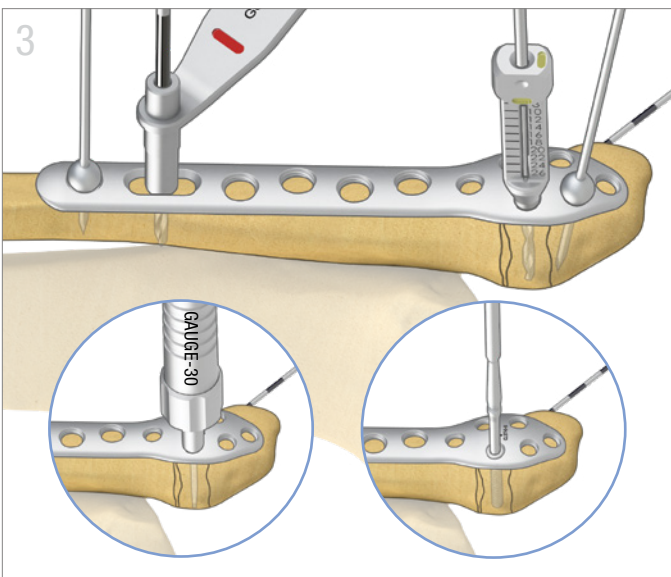

Plate Application

- With plate in desired location, secure with a reduction clamp or olive wires (1.6mm) as needed.
- Confirm position with fluoroscopy.



Screw Insertion

- Distally, use 2.7mm bone screws for fixation, using the 2.0mm (yellow) drill and the following corresponding guides.
- Use the 2.0/2.7 drill guide for non-locking screws or the 2.0mm locking drill guide for locking screws. Measure screw length with depth gauge and insert screws.
- Proximally, use 3.2mm bone screws for fixation, using the 2.3mm (red) drill and corresponding guides.
- Use the 2.3/3.2 drill guide for non-locking screws or the 2.3mm locking drill guide for locking screws. Measure screw length with depth gauge and insert screws.

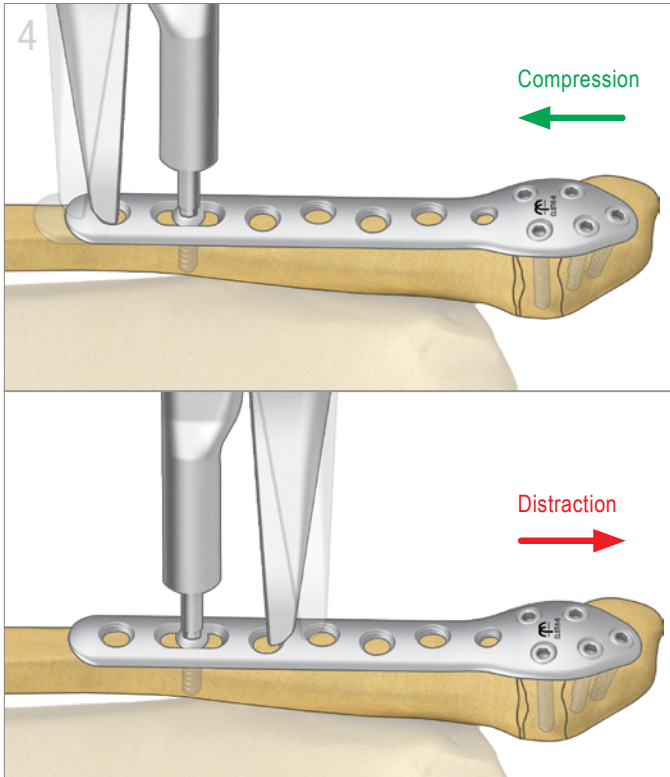

Option: Apply Compression or Restore Fibular Length

- The Expander/Compression Tool can be used during plate application to either (a) produce compression at fracture or (b) restore fibular length.
- Initially limit proximal fixation to a screw in the slotted hole. Insert distal screws as indicated. (a) To apply compression, place the screw at the proximal end of the hole. (b) To restore fibular length, place the screw at the distal end of the hole.
- Insert screwdriver tip of the Expander/Compression Tool into the screw head and slide the handle of the instrument down to engage the jaw into an adjacent screw hole. (a) Engage a more proximal hole for compression or (b) a more distal hole for restoring length.
- Slightly unfasten screw in the slotted hole. Slowly squeeze the handle of the instrument to restore length or compress the fracture, and retighten the screw.

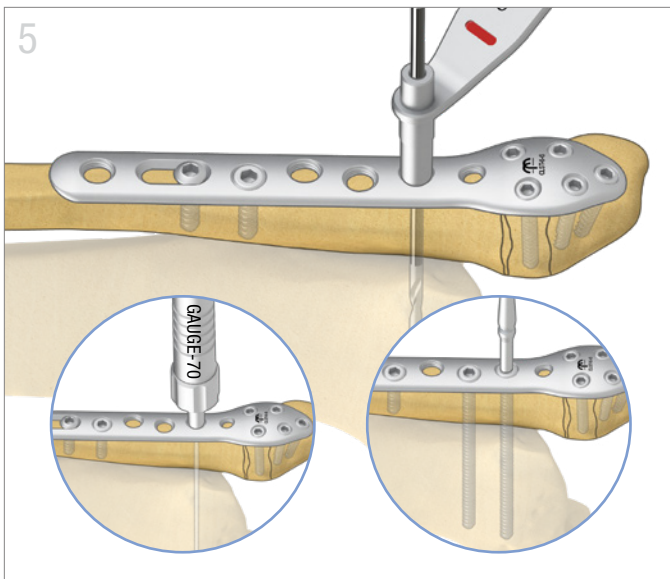

Option: Syndesmosis Fixation

- Syndesmosis fixation can be obtained with fixation directly through the Cluster plate.
- Leaving one or more proximal screw hole(s) available for syndesmosis fixation. Insert a 4.0mm syndesmosis screw using the 3.2mm (white) drill and corresponding drill guide.
- Measure hole(s) with appropriate depth gauge and insert the screw(s) across the syndesmosis.

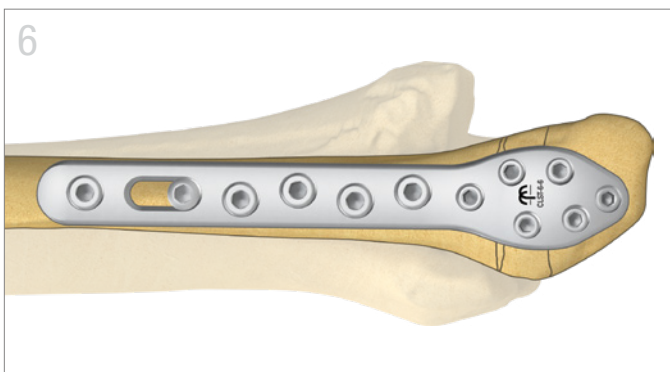

Final Fixation

- Complete fixation with additional screws as necessary.
- Confirm reduction, implant position and optimal screw lengths with fluoroscopy.

All implants made from surgical grade stainless steel

Cluster Plate

- CLST-6-6
- CLST-8-6
- CLST-12-6

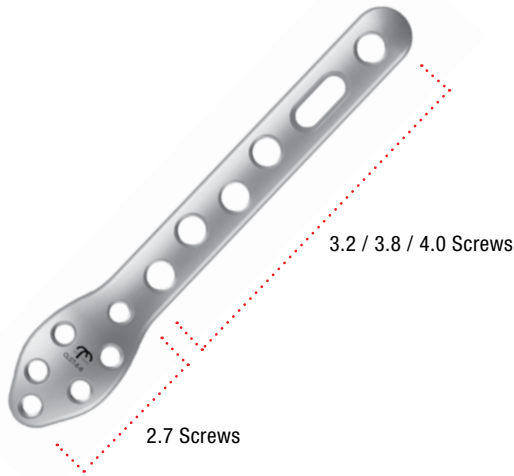

Locking Drill Guides

- GUIDELCBS-2.0
- GUIDELCBS-2.3



Cortical Screws

- 2.7mm** - HEX2.7-xx
08mm to 24mm
- 3.2mm** - HEX3.2-xx
08mm to 40mm



Locking Screws

- 2.7mm** - LCBS2.7-xx
08mm to 24mm
- 3.2mm** - LCBS3.2-xx
08mm to 24mm



Cancellous Screw

- 3.8mm** - CAB3.8-xx
10mm to 40mm



4.0 Cortical Screw

- HEX4.0-xx
35mm to 60mm

Expander/Compression Tool

XPANDR

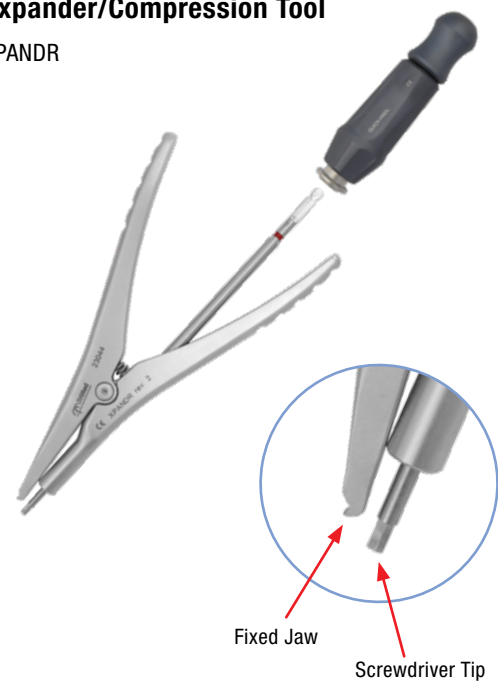

Fixed Jaw
Screwdriver Tip

TriMed, Inc. / 27533 Avenue Hopkins / Valencia, CA 91355 USA / 800-633-7221 / www.trimedortho.com

The technique presented is one suggested surgical technique. The decision to use a specific implant and the surgical technique must be based on sound medical judgment by the surgeon that takes into consideration factors such as the circumstances and configuration of the injury.

This document is controlled by TriMed, Inc. When downloaded, printed, and/or copied, this document becomes uncontrolled, and users should always check trimedortho.com for the latest version.

See trimedortho.com/patents for all patent information.

